

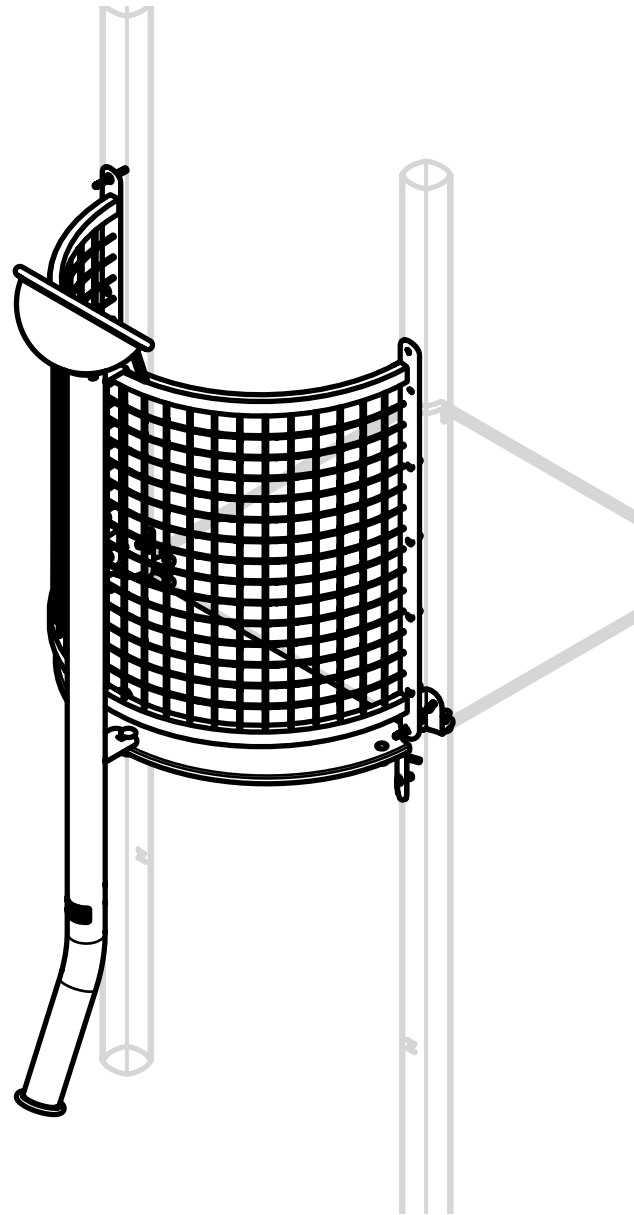





HAGS[®]

UniMini Sand Pipe with Balcony

MASW118240







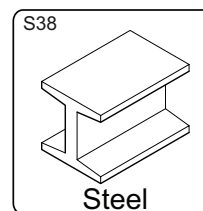





1	SW121118		1x	1593 x 218 x 216	8.10kg
2	31-03904		1x	765 x 706 x 335 mm	5.20kg
3	SW61297		1x	666 x 355 x 15 mm	3.90kg
4	SW73763		1x	97 x 78 x 38 mm	0.14kg
5	SW38071		1x	97 x 78 x 38 mm	0.14kg
6	8039292		1x	Screw, ISO8677-M10x35-8.8	0.04kg
7	8050050		1x	ISO7089-10.5x20x2	0.01kg
8	8008796		1x	M10-8-RingA2	0.01kg
10	43-04820		1x	Cover 10, Ø25x12mm	0.01kg
12	8008341		2x	Screw, ISO4017-M8x20-8.8	0.01kg
13	8008849		2x	9x18x2-ISO4759-3-C	0.01kg
14	43-04814		2x	Ø27x13 mm (8)	0.01kg

15	43-04816		2x	Ø18x10mm M8	0.01kg
16	8107022		2x	ISO8677-M6x30-A2.70	0.01kg
17	43-04812		2x	DISTANCE 6 Ø7x27x2,5	0.01kg
18	8008848		2x	6.4x14x1.6-ISO4759-3-C	0.01kg
19	8008794		2x	Nut, Fujilok-M6-8-RingA2	0.01kg
20	43-04810		2x	Cap 6 Ø6,5x21 mm	0.01kg
21	43-04811		2x	Cover M6, Ø15x10mm	0.01kg
22	43-04818		1x	CAP 10, Ø17x14,5 mm	0.01kg
23	8008902		18x	Blind rivet, MagnaLok-MGLP-R8-E (2-16)	0.01kg



1	SW121118		1x	1593 x 218 x 216	8.10kg
2	31-03904		1x	765 x 706 x 335 mm	5.20kg
3	SW61297		1x	666 x 355 x 15 mm	3.90kg
4	SW73763		1x	97 x 78 x 38 mm	0.14kg
5	SW38071		1x	97 x 78 x 38 mm	0.14kg
6	8039292		1x	Screw, ISO8677-M10x35-8.8	0.04kg
7	8050050		1x	ISO7089-10.5x20x2	0.01kg
8	8008796		1x	M10-8-RingA2	0.01kg
10	43-04820		1x	Cover 10, Ø25x12mm	0.01kg
12	8008341		2x	Screw, ISO4017-M8x20-8.8	0.01kg
13	8008849		2x	9x18x2-ISO4759-3-C	0.01kg
14	43-04814		2x	Ø27x13 mm (8)	0.01kg

15	43-04816		2x	Ø18x10mm M8	0.01kg
16	8107022		2x	ISO8677-M6x30-A2.70	0.01kg
17	43-04812		2x	DISTANCE 6 Ø7x27x2,5	0.01kg
18	8008848		2x	6.4x14x1.6-ISO4759-3-C	0.01kg
19	8008794		2x	Nut, Fujilok-M6-8-RingA2	0.01kg
20	43-04810		2x	Cap 6 Ø6,5x21 mm	0.01kg
21	43-04811		2x	Cover M6, Ø15x10mm	0.01kg
22	43-04818		1x	CAP 10, Ø17x14,5 mm	0.01kg
23	43-07232		20x	Ø6 16/7 x 3 mm	0.01kg
24	8008651		20x	TKFT-6x40-8.8	0.01kg

S37

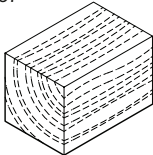

Wood

